

## Handbook

Fount je modulární stolový systém ocelové konstrukce, vhodný do běžného administrativního provozu všech typů kanceláří, call center, zasedacích či školících místností, knihoven apod. Základními prvky konstrukce jsou univerzální podélníky, bočnice v celé řadě provedení a stolová deska. Systém doplňuje bohatá nabídka příslušenství elektroinstalace a paravánů.

The Fount is a modular steel frame desk system intended for general office environments as well as call centres, meeting rooms and training rooms, libraries etc. The basic elements of the construction are universal stretchers, sides in a variety of designs and a table top. The system is complemented by a wide range of wiring accessories and screens.

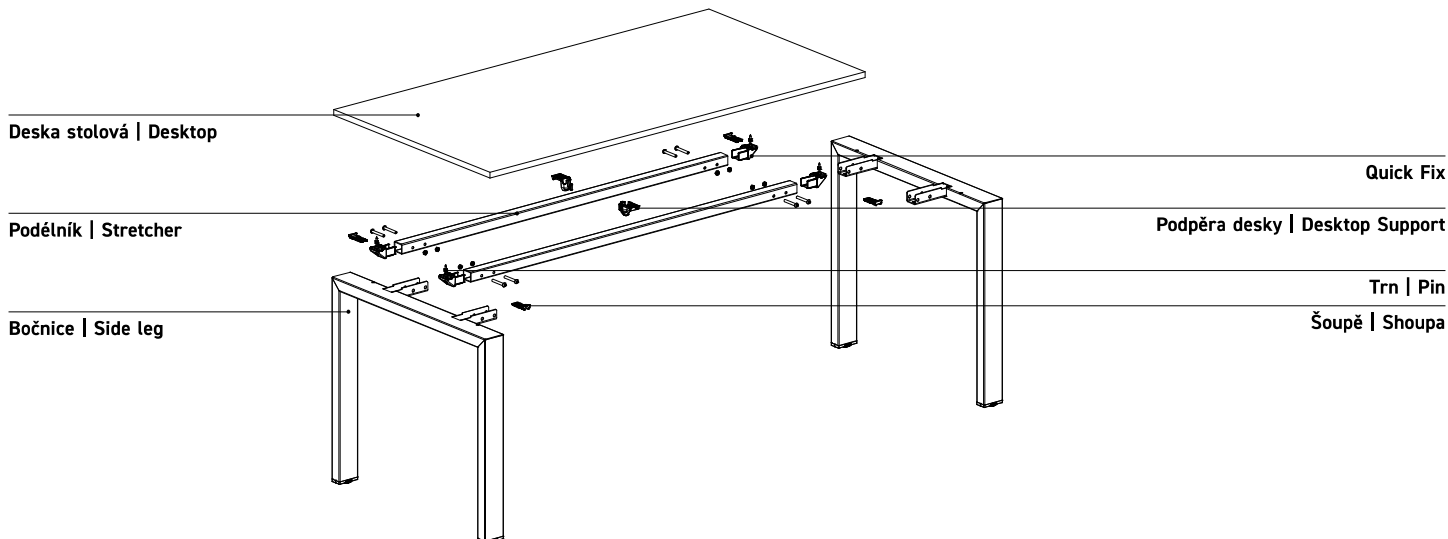

### Bočnice | Side leg

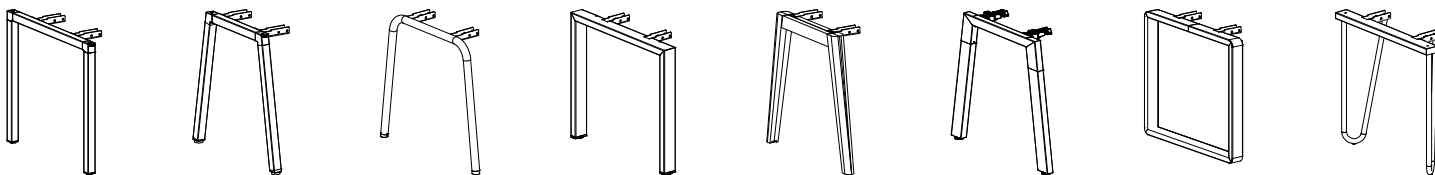

### Deska stolová | Desktop

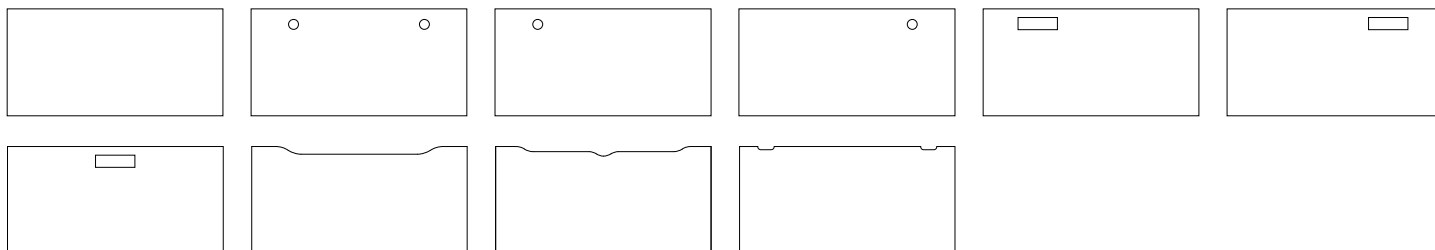

### Systém určení rozměrů | Dimensioning system

Rozměry jsou určeny z pohledu uživatele, případně podle orientace let u dřevodekoru.

The dimensions are determined from the user's point of view, or according to the orientation of the wood decor grain.

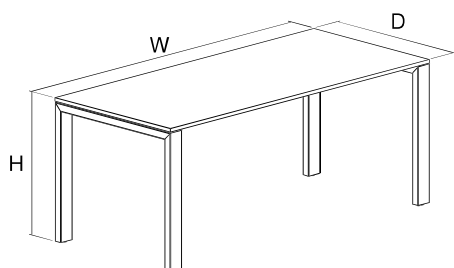

W - hrana rovnoběžná se směrem let | edge parallel to the wood decor grain

D - hrana kolmá na směr let | edge perpendicular to the wood decor grain

H - 750 mm včetně stolové desky 18 mm | 750 mm incl. desktop thickness 18 mm

Design nohy | Side leg design

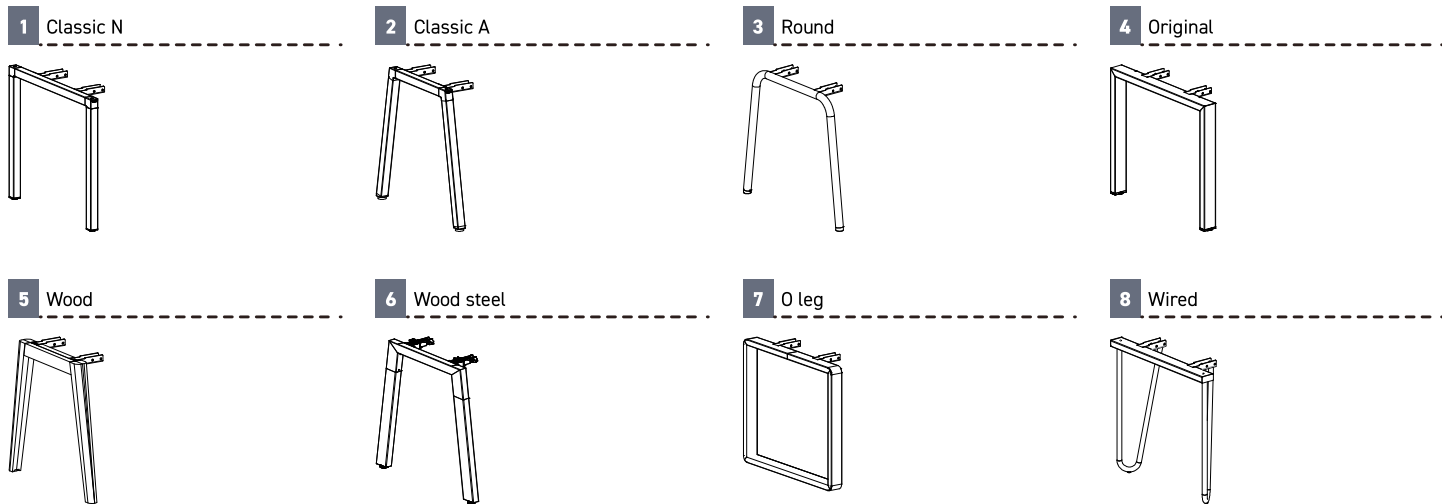
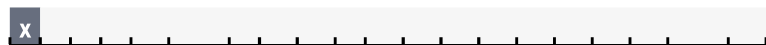

Typ stolu | Type of table

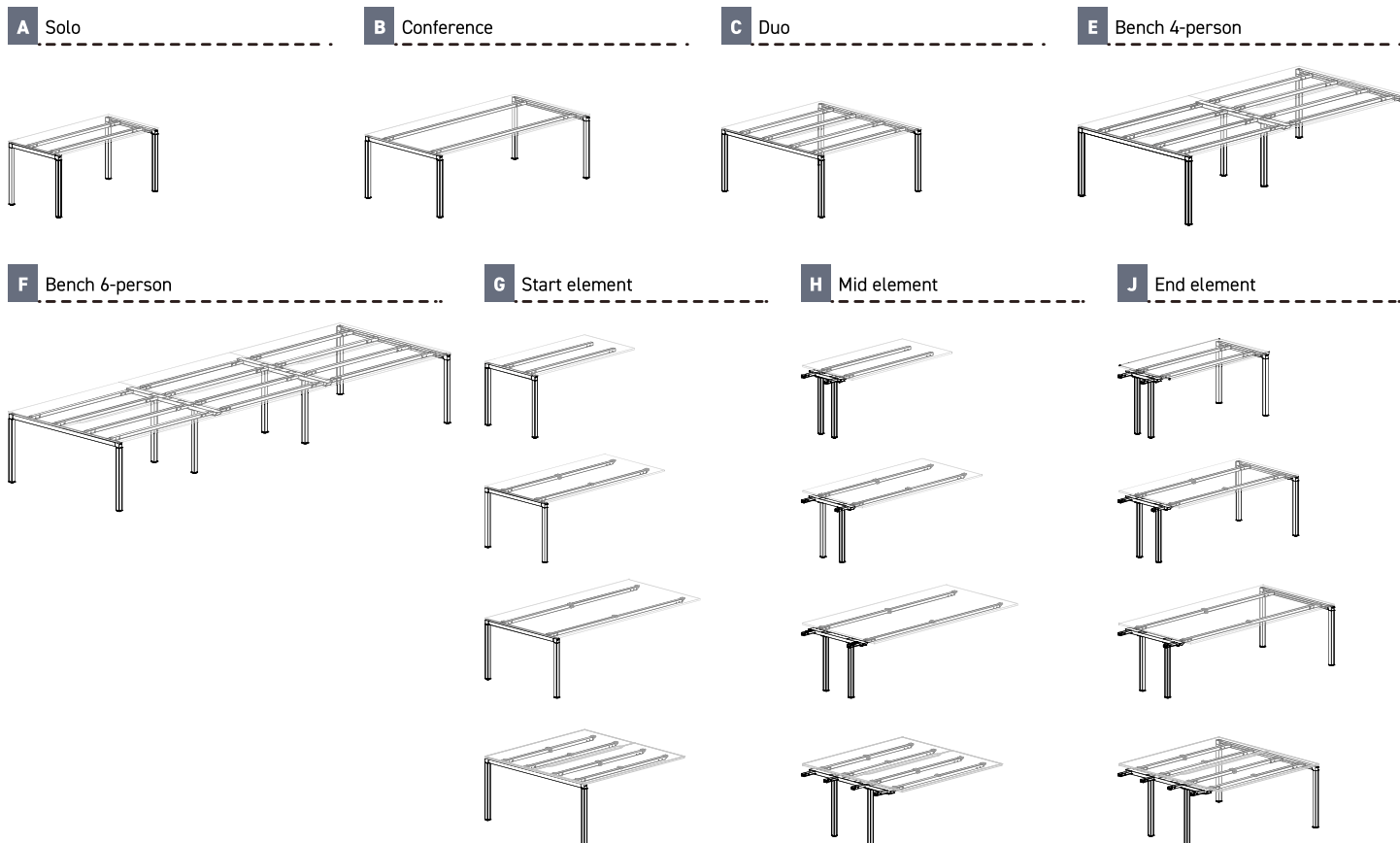
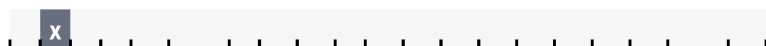

## Vytváření informačního kódu do systému Axis | Creating information code for the Axis system

### Hloubka stolu | Desktop depth



- 1** 80 cm solo
- 2** 100 cm conference
- 3** 120 cm conference
- 5** 160 cm conference

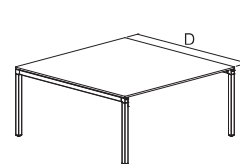
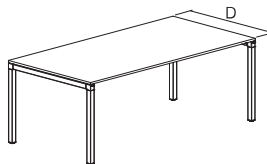
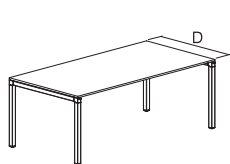
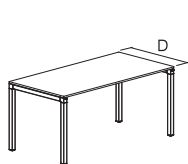

- 6** 160 cm duo (2 tops)

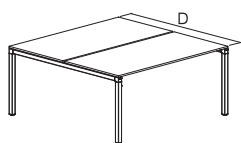

### Šířka stolu | Desktop width

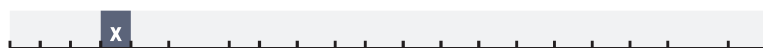

- |                 |                 |
|-----------------|-----------------|
| <b>A</b> 120 cm | <b>G</b> 280 cm |
| <b>B</b> 140 cm | <b>H</b> 320 cm |
| <b>C</b> 160 cm | <b>J</b> 360 cm |
| <b>D</b> 180 cm | <b>K</b> 420 cm |
| <b>E</b> 200 cm | <b>L</b> 480 cm |
| <b>F</b> 240 cm | <b>M</b> 540 cm |

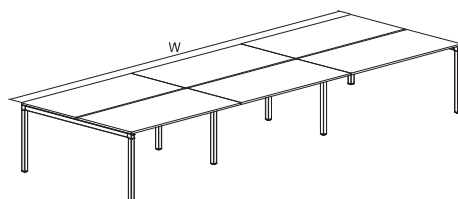
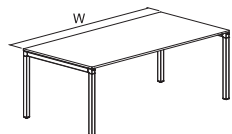

### Barva dřevěné bočnice | Wood side leg colour



- AT** Ash, transparent coated-wood
- OT** Oak, transparent coated-wood steel
- 00** Without wood side



## Vytváření informačního kódu do systému Axis | Creating information code for the Axis system

### Tloušťka desky, dekor desky stolu | Desktop thickness, desktop decor



**17XX** Thickness 18 mm      **22XX** Thickness 22 mm



<b>1710</b> White W10300VV	<b>1715</b> Light Grey U12188VV	<b>17EC</b> Talinn Light Beech R24053NW	<b>17KC</b> Okapi Walnut R301235NW	<b>17KM</b> Lindstrom Light Beech R24054NW
<b>17LO</b> Lindberg Oak R20021MO	<b>17xx</b> to be determined	<b>2210</b> White W10300VV	<b>2215</b> Light Grey U12188VV	<b>22EC</b> Talinn Light Beech R24053NW
<b>22KC</b> Okapi Walnut R301235NW	<b>22KM</b> Lindstrom Light Beech R24054NW	<b>22LO</b> Lindberg Oak R20021MO	<b>22xx</b> to be determined	

### Rádus rohu stolové desky | Desktop corner radius

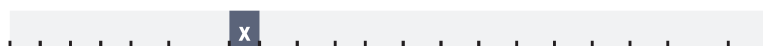

**0** Right angles, R=2      **1** Rounded angles, R=50



### Výřez/bez výřezu | Cutout/no cutout

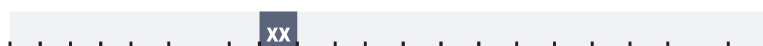

**00** Without cutout      **2K** 2x left/right for cable transits      **D0** Full width for accessories      **DK** Full width + extra cutout



## Vytváření informačního kódu do systému Axis | Creating information code for the Axis system

### Barevný kryt výřezu | Colour cover of cutout



- K3** White
- 15** Grey
- 19** Black
- 00** Without cutout

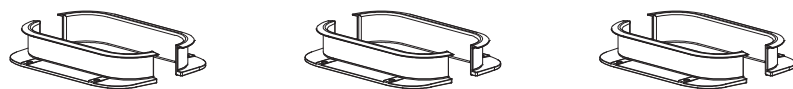

### Posuv | Slide



- 0** Without slide
- 1** With slide



### Paraván | Screen



- FK** Recessed screen
- FL** Screen total width table top
- 00** Without screen



Only for tops | Pouze pro desky

Only for tops | Pouze pro desky

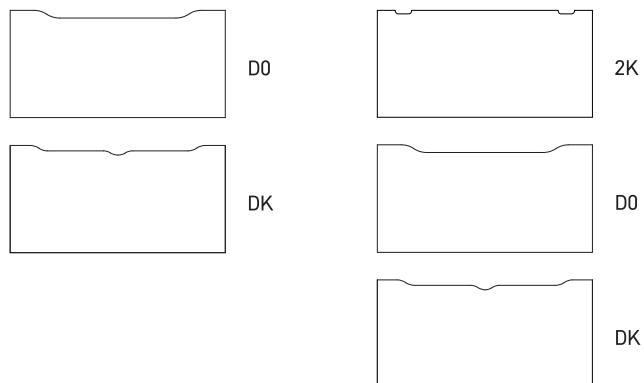

■ Příslušenství. Není součástí stolu. | Accessories. It is not part of the desk.

## Vytváření informačního kódu do systému Axis | Creating information code for the Axis system

### Průchodka vlevo | Grommet position left



**BA** ∅ 80 mm/Point/PuK/grommet    **UA** Fount ASA 240x100    **00** Without grommet

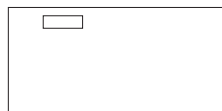
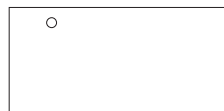

### Průchodka střed | Grommet position middle



**UA** ASA 240x100    **UB** ASA 320x100    **UC** ASA 240x100 central    **UD** ASA 320x100 central

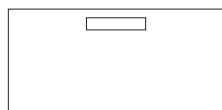
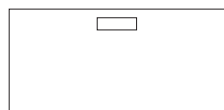

**00** Without grommet

### Průchodka vpravo | Grommet position right



**BA** ∅ 80 mm/Point/PuK/grommet    **UA** Fount ASA 240x100    **00** Without grommet



### Barva kovové bočnice | Metal side leg colour



**13** Pearl light grey RAL9022    **19** Black RAL9005 SG    **K1** White RAL9010 SG    **KY** Basalt gray RAL7012 SG    **L5** Signal black RAL9004 SG    **U5** Antracit gray RAL 7016

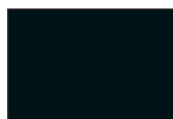

## Vytváření informačního kódu do systému Axis | Creating information code for the Axis system

### Barva podélníků, držáků ... | Colour of beams, brackets ...

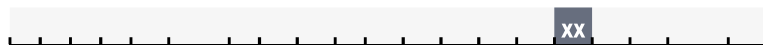

**19** Black - RAL9005 SG

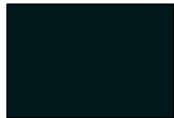

### Kabelový kanál | Cable tray

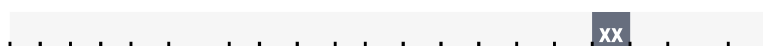

**C0** Set of cable clips



**C3** Set of cable clips + 3 socket PES

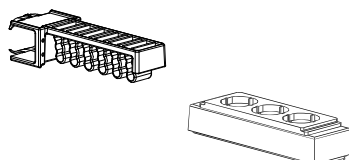

**C4** Set of cable clips + 4 socket PES

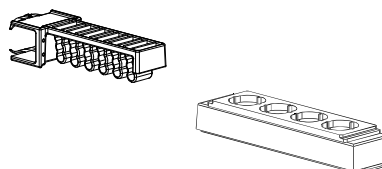

**M0** Cable tray

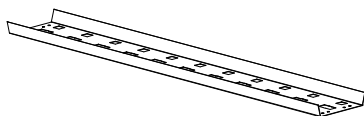

**M3** Cable tray + 3 socket PES

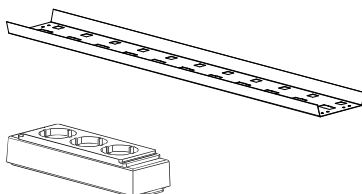

**M4** Cable tray + 4 socket PES

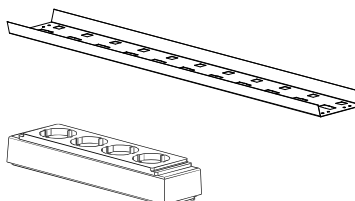

**00** Without cable tray

### Typ zásuvky | Socket type



**BE** Belgium/France

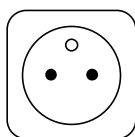

**EU** Europe (ex UK, BE, FR, IT)

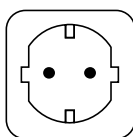

**UK** United Kingdom

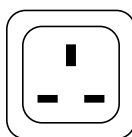

**00** Without socket

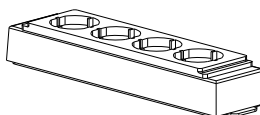
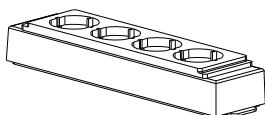

■ Příslušenství. Není součástí stolu. | Accessories. It is not part of the desk.

### Kabel propojovací | Connecting cable



**0000** Without connecting cable

**C227** Connecting cable 4 m

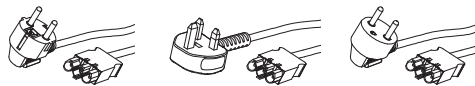

■ Příslušenství. Není součástí stolu. | Accessories. It is not part of the desk.

### Barva kabelového kanálu | Colour of cable channel

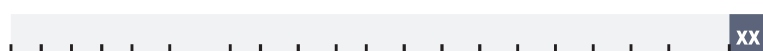

**13** Pearl light grey  
RAL9022



**19** Black  
RAL9005 SG

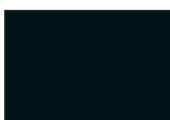

**K1** White  
RAL9010 SG



**KY** Basalt gray  
RAL7012 SG



**L5** Signal black  
RAL9004 SG



**U5** Antracit gray  
RAL 7016





Příslušenství | Accessories

Paraván | Screen

Kabelová průchodka d=80 | Grommet d=80

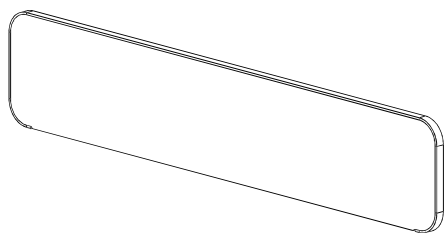

BOMBAY 84 art. 26		
width (mm)	height (mm)	
800	315	725212699
1000		725222699
1200		725232699
1400		725242699
1600		725252699
1800		725262699
2000		725272699
800	415	725312699
1000		725322699
1200		725332699
1400		725342699
1600		725352699
1800		725362699
2000		725372699

Vzorník látek BOMBAY | BOMBAY fabric samples



Držák paravánu Duo | Screen holder Duo

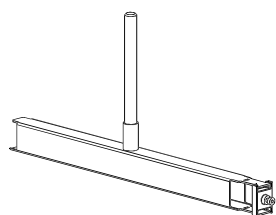

RAL9005



006310028

## Příslušenství | Accessories

### Kabelové průchodky | Grommets

Kabelová průchodka d=80 | Grommet d=80

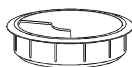

RAL9010	RAL9022	RAL9004
<b>005100227</b>	<b>005100210</b>	<b>005100239</b>

Průchodka ASA AxBx13 | Cable grommet ASA AxBx13

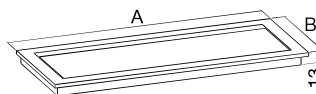

bílá   white		elox	
B=100		B=100	
A=240	<b>309603299</b>	A=240	<b>207316999</b>
A=320	<b>207619199</b>	A=320	<b>309725899</b>

### Typ zásuvky | Socket type

Netbox M3

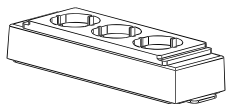

Netbox M3	Europe (Schuko)	UK	France, Belgium, CZ
	<b>207617699</b>	<b>602175299</b>	<b>602175199</b>

Netbox M4

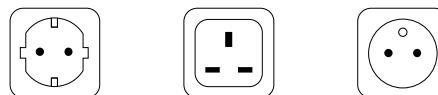
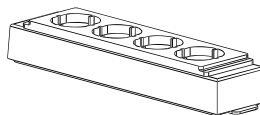

Netbox M3	Europe (Schuko)	UK	France, Belgium, CZ
	<b>602175399</b>	<b>602175599</b>	<b>602175499</b>

### Kabel propojovací | Connecting cable

Connecting cable 4 m

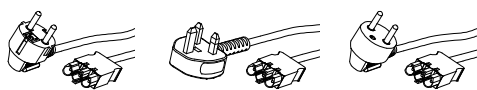

Netbox M3	Europe (Schuko)	UK	France, Belgium, CZ
	<b>602175799</b>	<b>602175899</b>	<b>602175699</b>

### Indukční nabíječka | Wireless charger

Charger



RAL9010	RAL9022	RAL9004
<b>XXXXXXXXX</b>	<b>XXXXXXXXX</b>	<b>XXXXXXXXX</b>