

# Techo Fount

Table Collection



# Techo Fount

Accessible, timeless and multifunctional. These are the key features of the Techo Fount Table Collection. Due to the smart, stable construction of frame, legs and tabletop, the modular collection gets a sleek look that works everywhere. The tables fit into any environment: in the office, in public spaces and even at home.

**Works  
everywhere**



# Collection

The collection consists of solo, duo, bench and conference tables and enables different ways of working, collaborating and meeting.

Eight types of legs have been developed for the table series. Each with its own unique look. The tabletops are available in many sizes, versions and decors.

Upholstered or felt panels can be added to the solo, duo and bench tables. They not only provide privacy and more focus, but also improve acoustics.

The legs, tabletops and panels can almost all be combined with each other. There are endless possibilities.

Mix &  
match





# Versions

The diversity of the Techo Fount Table Collection enables different ways of working, collaborating and meeting.

At the solo table, you can work independently for a longer period of time and stay focused. A colleague can join for a short, informal meeting.

The duo table is particularly suitable for focused co-working and informal meetings for two.

The bench table is ideal for collaborating in teams. This table is available for four, six or more workstations.

At the conference table, people can come together to meet, brainstorm and collaborate.

By opting for uniform legs, tabletops and panels, solo, duo, bench and conference tables can be perfectly combined in the same space.



# Legs

Eight types of legs, each with its own identity, were designed for the Techo Fount Table Collection. The legs are made of wood or steel or a combination of these. There are several lacquering colours to choose from for the finish of the steel.



**Original leg**  
solo, duo, bench and conference tables



**N-leg**  
solo, duo, bench and conference tables



**A-leg**  
solo, duo, bench and conference tables



**Round leg**  
solo, duo and bench tables



**Wood leg**  
solo, duo, bench and conference tables



**Wood-steel leg**  
solo, duo and bench tables



**O-leg**  
solo, duo and bench tables



**Wired leg**  
duo and bench tables

## Lacquering colours\*

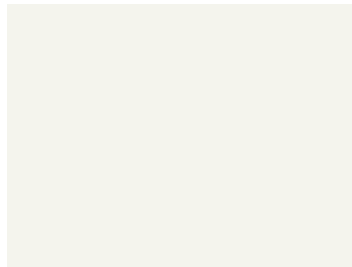

RAL 9010



RAL 9022



RAL 7012



RAL 9005



RAL 9004



RAL 7016

## Wood



**Ash**  
For wood leg



**Oak**  
For wood-steel leg

\*The frame and brackets for the panels are always lacquered in black.







# Tabletops

The tabletops are available in many sizes and have straight or rounded edges. There is a suitable tabletop for every space. They are suspended above the legs and equipped with the patented Quick fix system for fast and easy (dis)assembly.

The laser-edged tabletops are made of 18 or 22 mm thick MFC with a wide choice of top layer decors.

The tabletops can be equipped with a long cut-out (available in two types) for:

- panels
- cable feed
- surface-mounted electrification
- surface-mounted monitor arms

or with a short cut-out for:

- panels
- cable feed

There are many options for surface-mounted and built-in electrification and cable management for this table series. Horizontal cable trays and cable clips can be installed under the tabletops to neatly hide all electrification. The tables can be equipped with a lockable sliding top so that cabling and electrification are easily accessible from above.





## Shapes



Straight edge



Rounded edge  
(radius 50 mm)

## Decors



**KM** Grey beech (M)



**EC** Light beech (M)

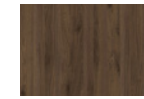

**KC** Walnut (M)



**15** Grey (M)

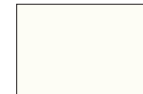

**10** White (M)



**LO** Oak (M)

M Melamine

# Panels

For a fully-fledged workplace, panels can be added to the solo, duo and bench tables in the collection. They provide privacy and more focus and contribute to improving the acoustics in the room. That way, you can get to work undisturbed.

The panels come in the same widths as the tabletops: 120, 140, 160, 180 and 200 cm

There is also a recessed variant:

- 80 cm for a 120 or 140 cm table
- 100 cm for a 140 or 160 cm table
- 120 cm for a 160 or 180 cm table

Panel height from the ground is 108 or 118 cm, panel thickness is 25 mm.



The panels are suspended above the tabletop with a bracket that is attached to the frame. The panels are only possible in tabletops with a cut-out.

The panels have rounded edges on both sides and are upholstered or made of felt.

### Upholstery\*

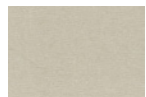

Bombay  
04

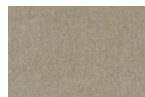

Bombay  
24

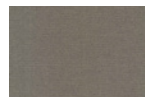

Bombay  
34

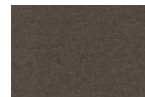

Bombay  
64



Bombay  
06

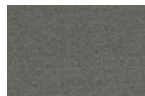

Bombay  
26

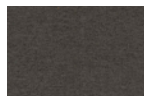

Bombay  
36



Felt  
Grey

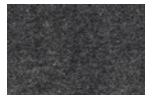

Felt  
Anthracite



\*This is a selection for inspiration. More colours are possible.



# Dimensions

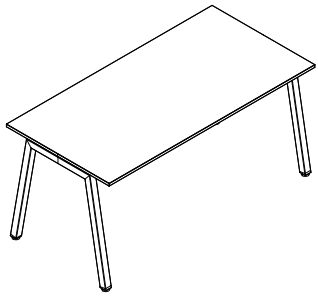

## Solo table

Width: 120/140/160/180/200 cm  
Depth: 80 cm  
Height: 75 cm

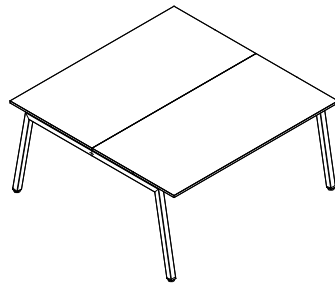

## Duo table

Width: 120/140/160/180 cm  
Depth: 2x 80 cm  
Height: 75 cm

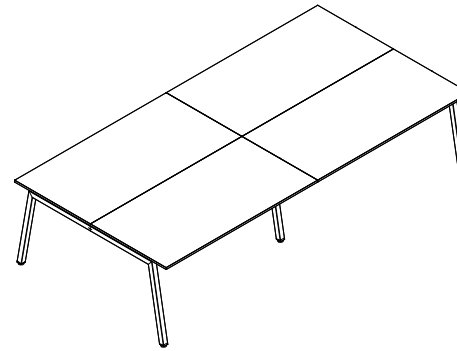

## Benchtable

Width: 120/140/160/180 cm  
(x2 or more)  
Depth: 2x 80 cm  
Height: 75 cm

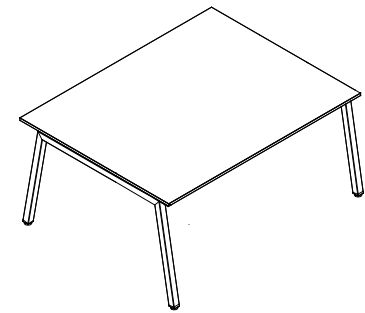

## Conference table

Width: 160/180/200/240 cm  
Depth: 100/120 cm  
Height: 75 cm

# Contact

We are Techo, one of the global office furniture brands of the Royal Ahrend Group. Our clever, modular products offer comfort and convenience and support the user in achieving his goals. For every situation there is a design that meets the needs of our customers. Due to the accessible appearance, our furniture fits into any environment. From office to home workplace, from lobby to retail space.

Techno furniture works everywhere.

©Royal Ahrend All rights reserved

No part of this publication may be reproduced, stored in a retrieval system, or transmitted in any form or by any means, electronic, mechanical, photocopying, recording or otherwise, without the prior written permission of the publisher. Interested parties are being requested to contact [communications@ahrend.com](mailto:communications@ahrend.com)

## Inspiration Centres

Amsterdam, The Netherlands  
Laarderhoogtweg 25  
+31 88 00 60 000

St. Oedenrode, The Netherlands\*  
Kofferen 60  
+31 88 00 60 000

Brussels, Belgium  
Romboutsstraat 9  
+32 2 716 22 00

Paris, France  
Rue de Paris 2  
+33 1 40 95 24 54

Prague, Czech Republic\*  
U Továren 770/1b  
+420 224 810 148

Shanghai, China  
Unit 208, No. 358 Xuijiahui Rd  
+86 512 5310 2388

## Showrooms

Bratislava, Slovakia  
Cesta na Červený most 12  
+421 2 57 88 07 88

Bucharest, Romania  
Sos. Orhideelor 15 D,  
Cladirea 1, sector 6  
+40 21 316 81 11

Budapest, Hungary  
Neumann János u. 1.  
+36 30 971 2336  
+36 30 564 3554

Dubai, United Arab Emirates  
Dubai Design District, Building 1B  
- Office 507 & 508  
+971 4589 988

Köln, Germany  
Zollstockgürtel 61  
+49 221 168500 08

London, United Kingdom  
17 Charterhouse Buildings  
+44 20 - 7566 7466

Taicang, China\*  
135 Yanshan W Rd Suzhou,  
Jiangsu Taicang  
+86 512 5310 2388

Tbilisi, Georgia  
33 Chavchavadze ave  
+995 2 22 30 87

Warsaw, Poland  
Karolkowa Business Park, ul.  
Karolkowa 30  
+420 733 736 021

Wien, Austria  
Margaretenstraße 87/1-7  
+43 676 4514571

Zagreb, Croatia  
Ulica kneza Branimira 22  
+385 99 700 4950

\* Also production location

techo

WORKS EVERYWHERE